

(PL) Instrukcja montażu  
 (D) Aufbauanleitung  
 (GB) Assembly instruction  
 (SK) Návod na montáž

Łóżko  
 Bettgestell  
 Bed  
 Postel'

# TIX-S

## (12-20)

### ⚠ UWAGA

Drogi kliencie, przed rozpoczęciem montażu upewnij się, czy posiadasz wszystkie niezbędne elementy pokazane w instrukcji.

W przypadku domówienia mebla tapicerowanego tkaniną w takim samym kolorze jak zakupione wcześniej meble, może wystąpić różnica w odcieniach wybranej tkaniny.

### ⚠ ACHTUNG

Sehr geehrter Kunde. Bitte überprüfen Sie vor Beginn der Montage die Vollständigkeit unten aufgeführten Bauteile.

Bei einer Nachbestellung dieser Artikel können Farbabweichungen bei den gewählten Stoffen sein.

### ⚠ CAUTION

Dear Customer, before assembly, ensure that you have all the necessary elements specified in the instruction.

In case of ordering the same fabric in different time, the colour of fabric may be a little bit different.

### ⚠ POZOR

Vážený zákazník, pred montážou sa prosíme uistiť či v balení sú všetky potrebné diely znázornené v návode.

V prípade objednania textilie čalúnený nábytok v rovnakej farbe ako predtým zakúpeného nábytku, môže byť rozdiel v odtieňoch zvolenej látky.

Oznaczenia kontrolne  
 Bezeichnungen steuern  
 Control marks  
 Označenie ovládat'





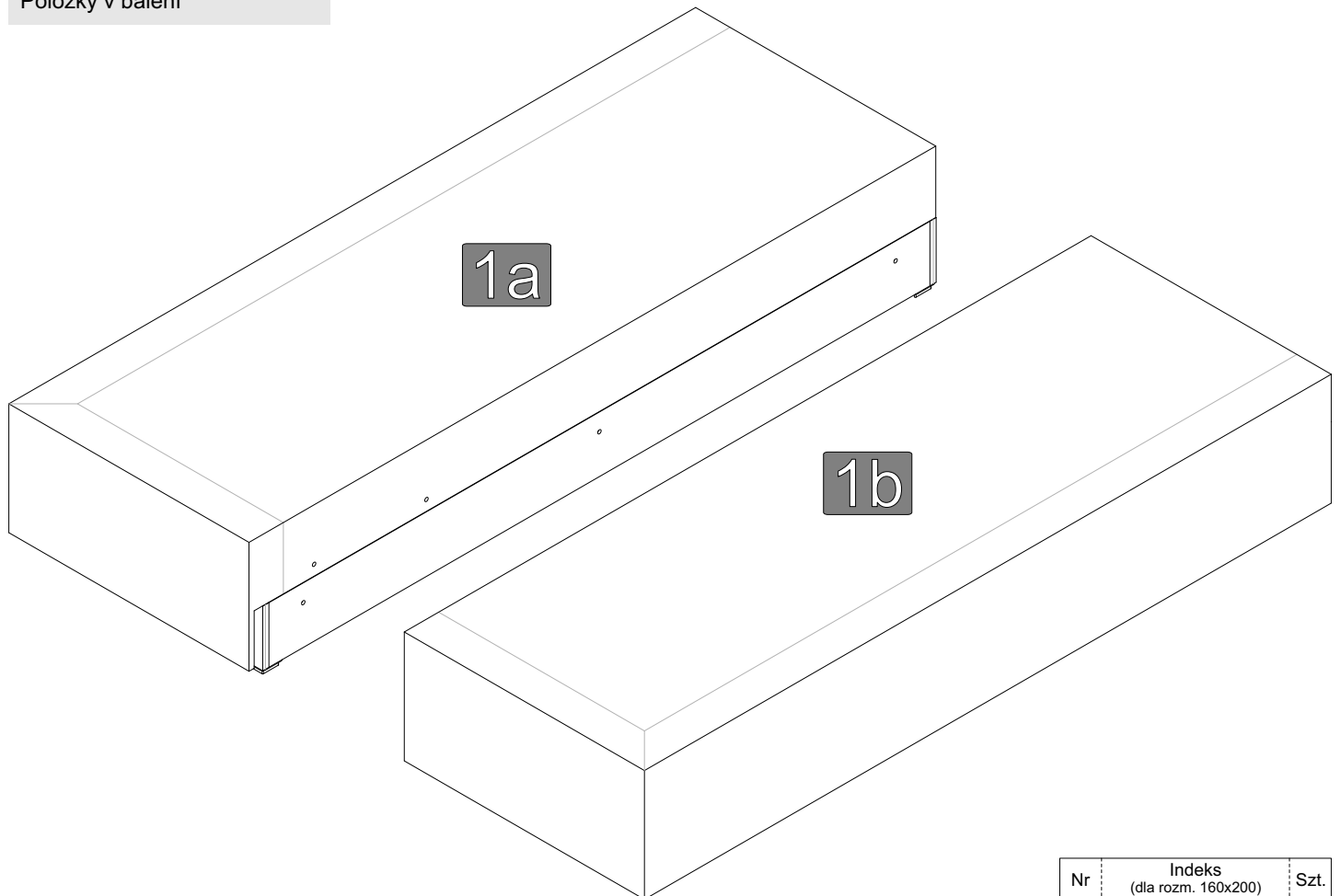



Elementy w paczkach  
 Befestigungsmaterial im Paket  
 Items in the packages  
 Položky v balení





Nr	Indeks (dla rozm. 160x200)	Szt.
1a	X-TIKS-SKL0820	1
	X-TIKS-LEL0820	1
1b	X-TIKS-SKP0820	1
	X-TIKS-LEP0820	1

Elementy w worku serwisowym  
 Befestigungsmaterial im Servicebeutel  
 Items in bag service  
 Položky v sáčku služby

**X\_TIX-WSD**

A	B	C	D	E	F	G
	Ericson 					OSL-NAK-M8 
M6 x 30	M6 x 15		M8 x 140	8x16x1,8	M8	
3 x	3 x	6 x	2 x	2 x	2 x	2 x

H	I
	
4	5
2 x	1 x

Dodatkowe elementy niezbędne do sprawnego montażu  
 Zusätzliche Komponenten für eine reibungslose Installation  
 Additional components needed for a smooth assembly  
 Ďalšie komponenty potrebné pre správny inštaláciu

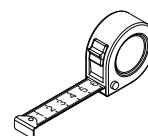
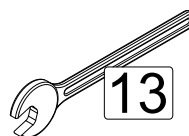

**Instrukcja montażu - Aufbauanleitung - Assembly instruction - Návod na montáž**

KROK  
 SCHRITT  
 STEP **1.**

